

# MAX-BAR 6mm 35° SERIES TOOLING



## FRONT TURN

( REG. U.S. PATENT )  
 ( NO. 5,779,400 )  
 ( NO. 6,033,158 )

WITH ONE TOOLHOLDER  
 JUST CHANGE INSERT

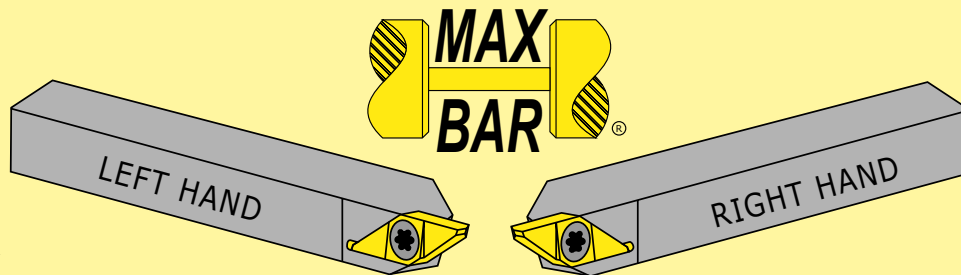

### FRONT TURN

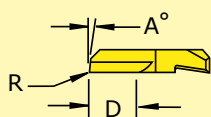
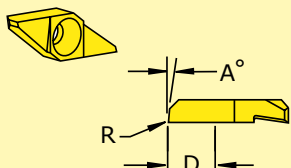

\* WITH CHIP CONTROL

RIGHT HAND SHOWN

R.H. INSERT NO.	L.H. INSERT NO.	A°	DEPTH		RADIUS	
			INCH	MM	INCH	MM
VFTR-6M010	VFTL-6M010	1°	.200	5,00	.000	0,00
VFTR-6M040	VFTL-6M040	4°	.200	5,00	.000	0,00
VFTR-6M152	VFTL-6M152	15°	.200	5,00	.002	0,05
VFTR-6M157	VFTL-6M157	15°	.200	5,00	.007	0,18
* VFTRB-6M010	* VFTLB-6M010	1°	.200	5,00	.000	0,00
* VFTRB-6M040	* VFTLB-6M040	4°	.200	5,00	.000	0,00
* VFTRB-6M152	* VFTLB-6M152	15°	.200	5,00	.002	0,05
* VFTRB-6M157	* VFTLB-6M157	15°	.200	5,00	.007	0,18

### TOOLHOLDERS

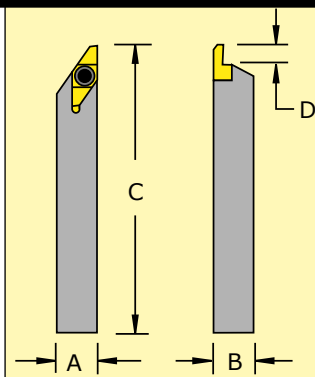

RIGHT HAND SHOWN

R.H. HOLDER NO.	L.H. HOLDER NO.	A	B	C	D
SVANR-07M6M-C	SVANL-07M6M-C	7mm	7mm	127mm	5mm
SVANR-08M6M-C	SVANL-08M6M-C	8mm	8mm	127mm	5mm
SVANR-10M6M-C	SVANL-10M6M-C	10mm	10mm	127mm	5mm
SVANR-12M6M-C	SVANL-12M6M-C	12mm	12mm	127mm	5mm
SVANR-3756M-C	SVANL-3756M-C	.375	.375	5.00	.200
SVANR-5006M-C	SVANL-5006M-C	.500	.500	5.00	.200
SVANR-6256M-C	SVANL-6256M-C	.625	.625	5.00	.200
SVANR-7506M-C	SVANL-7506M-C	.750	.750	5.00	.200
SPARE PARTS	SCREW 2.40-064	WRENCH T-7			

### MAX-BAR 6mm 35° DIAMOND BARS

FOR TURRET & GANG LOADING/BACK WORKING

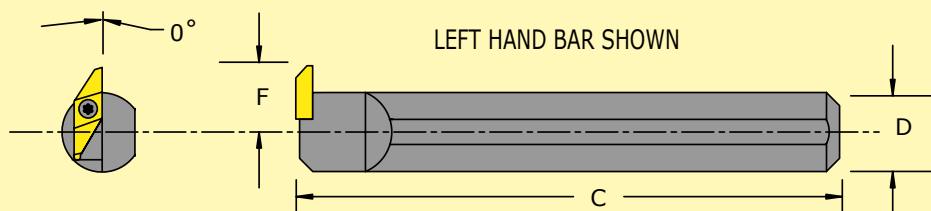

R.H. BAR NO.	L.H. BAR NO.	INSERT	D	C	F	SCREW	WRENCH
S10D-SVFNR6M	S10D-SVFNL6M	6MM-35	.625	5.75	.515	2.40-064	T-7
S12D-SVFNR6M	S12D-SVFNL6M	6MM-35	.750	5.75	.575	2.40-064	T-7

NOTE: RIGHT HAND BARS USE LEFT HAND INSERTS/LEFT HAND BARS USE RIGHT HAND INSERTS

# MAX-BAR 8mm 35° SERIES TOOLING

(FORMERLY 2.5 SERIES)



## FRONT TURN

RIGHT HAND SHOWN

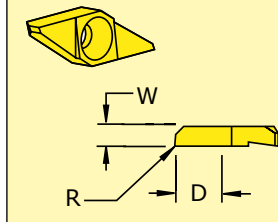

		WIDTH		DEPTH		RADIUS	
R.H. INSERT NO.	L.H. INSERT NO.	INCH	MM	INCH	MM	INCH	MM
VFTR-8M040	VFTL-8M040	.156	4,00	.300	7,62	.000	0,00
VFTR-8M045	VFTL-8M045	.156	4,00	.300	7,62	.005	0,13
*VFTRB-8M040	*VFTLB-8M040	.156	4,00	.300	7,62	.000	0,00
*VFTRB-8M045	*VFTLB-8M045	.156	4,00	.300	7,62	.005	0,13

\*WITH CHIP CONTROL

## TOOLHOLDERS

RIGHT HAND SHOWN

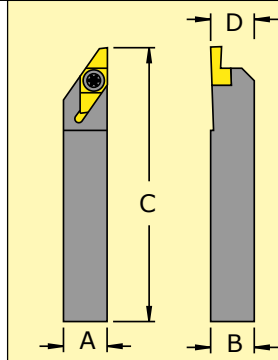

R.H. HOLDER NO.	L.H. HOLDER NO.	A	B	C	D
SVANR-3758M-V	SVANL-3758M-V	.375	.375	3.50	.380
SVANR-3758M-C	SVANL-3758M-C	.375	.375	5.00	.380
SVANR-10M8M-C	SVANL-10M8M-C	10mm	10mm	127mm	10mm
SVANR-12M8M-C	SVANL-12M8M-C	12mm	12mm	127mm	12mm
SVANR-5008M-V	SVANL-5008M-V	.500	.500	3.50	.505
SVANR-5008M-C	SVANL-5008M-C	.500	.500	5.00	.505
SVANR-6258M-C	SVANL-6258M-C	.625	.625	5.00	.630
SPARE PARTS		SCREW 3.20-095		WRENCH T-10	

# MAX-BAR 10 SERIES TOOLING

FOR BAR DIAMETERS UP TO 3/8" (10mm)

## FRONT TURN

RIGHT HAND SHOWN

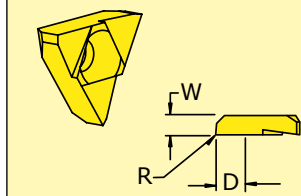

		WIDTH		DEPTH		RADIUS	
R.H. INSERT NO.	L.H. INSERT NO.	INCH	MM	INCH	MM	INCH	MM
TFTR-3040	TFTL-3040	.125	3,18	.230	5,84	.000	0,00
TFTR-3045	TFTL-3045	.125	3,18	.230	5,84	.005	0,13
*TFTRB-3040	*TFTLB-3040	.125	3,18	.230	5,84	.000	0,00
*TFTRB-3045	*TFTLB-3045	.125	3,18	.230	5,84	.005	0,13

\*WITH CHIP CONTROL

## TOOLHOLDERS

RIGHT HAND SHOWN

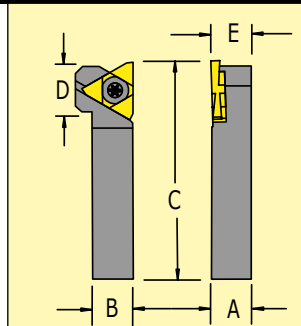

R.H. Holder No.	L.H. Holder No.	A	B	C	D	E
STANR-053-V	STANL-053-V	.312	.312	3.50	.550	.317
STANR-063-V	STANL-063-V	.375	.375	3.50	.550	.380
STANR-063-C	STANL-063-C	.375	.375	5.00	.550	.380
STANR-083-V	STANL-083-V	.500	.500	3.50	.550	.505
STANR-083-C	STANL-083-C	.500	.500	5.00	.550	.505
STANR-103-V	STANL-103-V	.625	.625	3.50	---	.630
SPARE PARTS		SCREW 3.50 - 095		WRENCH T-15		

# MAX-BAR 16 SERIES TOOLING

FOR BAR DIAMETERS UP TO 5/8" (16mm)



## FRONT TURN

RIGHT HAND SHOWN

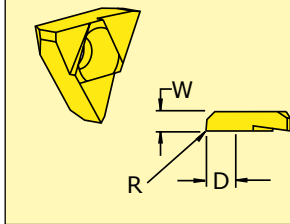

		WIDTH		DEPTH		RADIUS	
R.H. INSERT NO.	L.H. INSERT NO.	INCH	MM	INCH	MM	INCH	MM
TFTR-4040	TFTL-4040	.187	4,75	.350	8,90	.000	0,00
TFTR-4045	TFTL-4045	.187	4,75	.350	8,90	.005	0,13
*TFTRB-4040	*TFTLB-4040	.187	4,75	.350	8,90	.000	0,00
*TFTRB-4045	*TFTLB-4045	.187	4,75	.350	8,90	.005	0,13

\*WITH CHIP CONTROL

## TOOLHOLDERS

RIGHT HAND SHOWN

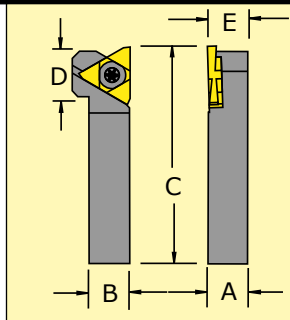

R.H. Holder No.	L.H. Holder No.	A	B	C	D	E
STANR-064-V *	STANL-064-V *	.375	.375	3.50	.750	.380
STANR-064-C *	STANL-064-C *	.375	.375	5.00	.750	.380
STANR-084-V	STANL-084-V	.500	.500	3.50	.750	.505
STANR-084-C	STANL-084-C	.500	.500	5.00	.750	.505
STANR-104-V	STANL-104-V	.625	.625	3.50	.750	.630
STANR-124-C	STANL-124-C	.750	.750	5.00	---	.755
SPARE PARTS		SCREW *4.06-095 4.06-127			WRENCH T-20	

# MAX-BAR 20 SERIES TOOLING

FOR BAR DIAMETERS UP TO 3/4" (20mm)

## FRONT TURN

RIGHT HAND SHOWN

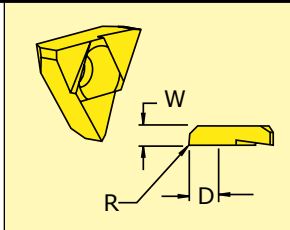

		WIDTH		DEPTH		RADIUS	
R.H. INSERT NO.	L.H. INSERT NO.	INCH	MM	INCH	MM	INCH	MM
TFTR-5040	TFTL-5040	.250	6,35	.440	11,2	.000	0,00
TFTR-5045	TFTL-5045	.250	6,35	.440	11,2	.005	0,13
*TFTRB-5040	*TFTLB-5040	.250	6,35	.440	11,2	.000	0,00
*TFTRB-5045	*TFTLB-5045	.250	6,35	.440	11,2	.005	0,13

\*WITH CHIP CONTROL

## TOOLHOLDERS

RIGHT HAND SHOWN

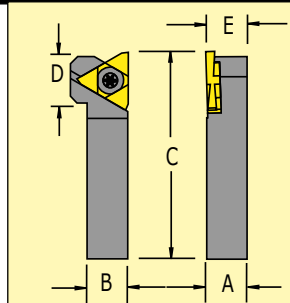

R.H. Holder No.	L.H. Holder No.	A	B	C	D	E
STANR-085-V	STANL-085-V	.500	.500	3.50	.920	.505
STANR-085-C	STANL-085-C	.500	.500	5.00	.920	.505
STANR-105-V	STANL-105-V	.625	.625	3.50	.920	.630
STANR-105-D	STANL-105-D	.625	.625	4.50	.920	.630
STANR-125-C	STANL-125-C	.750	.750	5.00	.920	.755
SPARE PARTS		SCREW 4.76-127			WRENCH T-25	

# MAX-BAR 50° SERIES TOOLING



## FRONT TURN

RIGHT HAND SHOWN

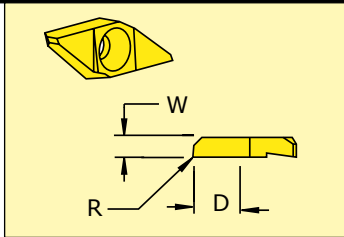

R.H. INSERT NO.	L.H. INSERT NO.	WIDTH		DEPTH		RADIUS	
		INCH	MM	INCH	MM	INCH	MM
KFTR-4040	KFTL-4040	.187	4,75	.300	7,62	.000	0,00
KFTR-4045	KFTL-4045	.187	4,75	.300	7,62	.005	0,13
*KFTRB-4040	*KFTLB-4040	.187	4,75	.300	7,62	.000	0,00
*KFTRB-4045	*KFTLB-4045	.187	4,75	.300	7,62	.005	0,13

\*WITH CHIP CONTROL

## TOOLHOLDERS

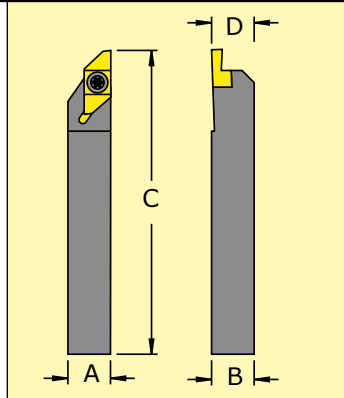

R.H. HOLDER NO.	L.H. HOLDER NO.	A	B	C	D
SKANR-104-V	SKANL-104-V	.625	.625	3.50	.630
SKANR-104-C	SKANL-104-C	.625	.625	5.00	.630
SKANR-124-V	SKANL-124-V	.750	.750	3.50	.755
SKANR-124-C	SKANL-124-C	.750	.750	5.00	.755
SKANR-164-C	SKANL-164-C	1.00	1.00	5.00	1.00
SPARE PARTS	SCREW 4.76-127	WRENCH T-25			

## MAX-BAR RIGHT ANGLE HOLDERS

FOR TURRET & GANG LOADING

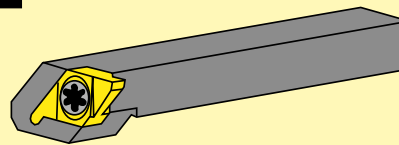
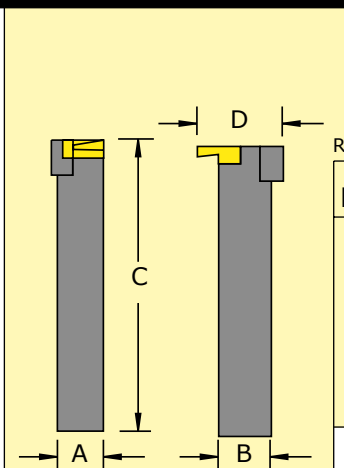

RIGHT HAND SHOWN

R.H. HOLDER NO.	L.H. HOLDER NO.	A	B	C	D	SCREW	WRENCH
SKFNR-064-D	SKFNL-064-D	.375	.500	4.50	1.15	4.76-127	T-25
SKFNR-084-D	SKFNL-084-D	.500	.500	4.50	1.15	4.76-127	T-25
SKFNR-104-D	SKFNL-104-D	.625	.625	4.50	1.15	4.76-127	T-25
SKFNR-124-C	SKFNL-124-C	.750	.750	5.00	1.05	4.76-127	T-25
SKFNR-164-C	SKFNL-164-C	1.00	1.00	5.00	1.30	4.76-127	T-25

NON-STANDARD SHANK SIZES AND RECTANGULAR SHANKS AVAILABLE ON REQUEST

NOTE: RIGHT HAND HOLDERS USE LEFT HAND INSERTS. LEFT HAND HOLDERS USE RIGHT HAND INSERTS.